

# CONTINUOUS API MANUFACTURE

Roland Guidat  
Chief Reactor Engineer  
CORNING SAS  
October 16-17, 2013



# Outline

- Introduction to Corning
- Continuous flow and process understanding
- Continuous flow and process control
- Continuous flow and material certification
- A case of industrial production of API in flow
- Conclusion

# Corning is the world leader in specialty glass and ceramics

Founded in 1851

Headquartered in Corning, NY

Global operations

Over 24,000 employees

Fortune 500 Rank (2012): 328

\$8 billion sales (2012)

~ 10% of annual sales to R&D



# Corning's continuous flow reactors build on the company's 160 years of innovation

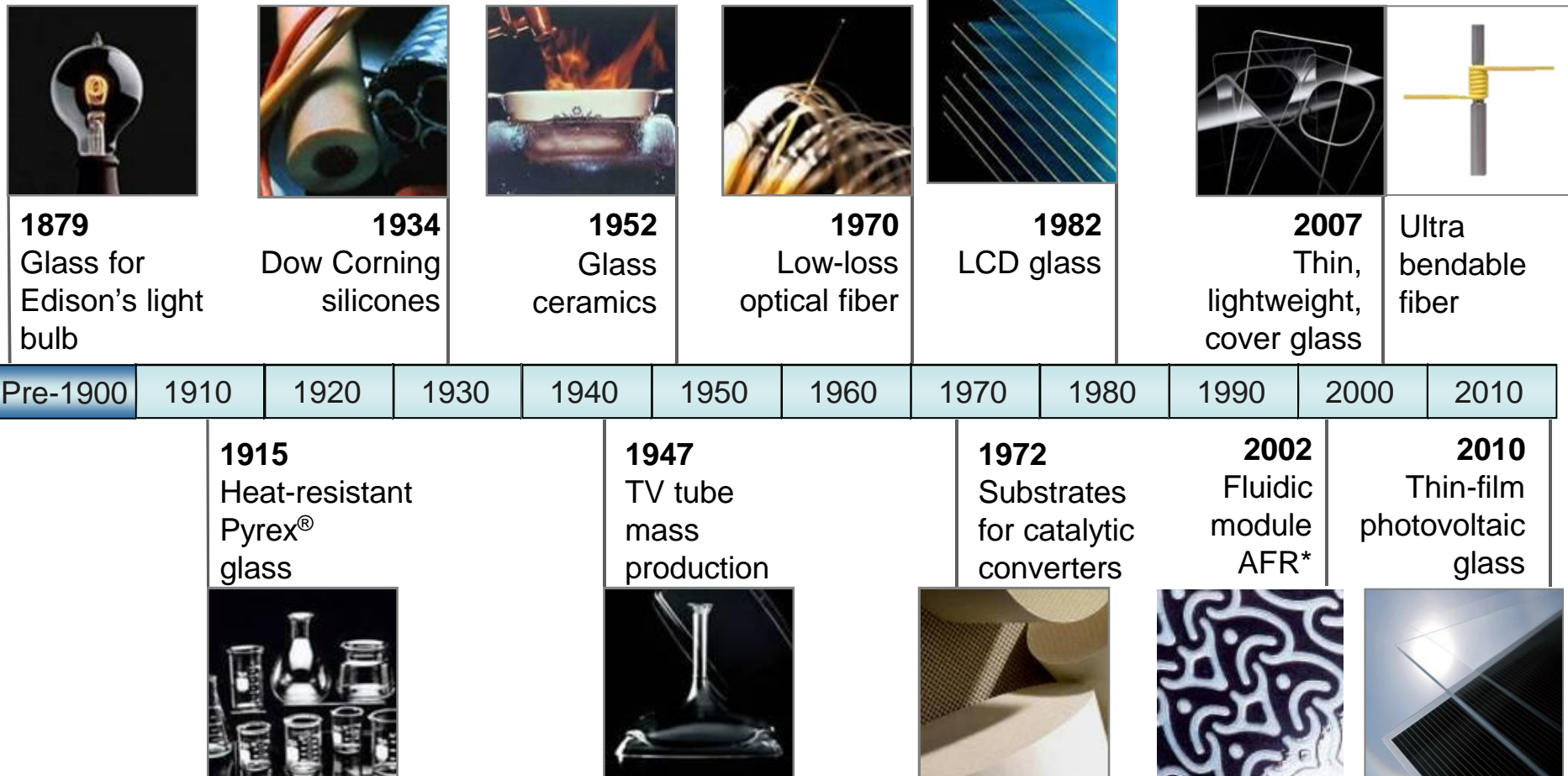

\* Advanced-Flow™ Reactors

# Corning Gorilla Glass®



# History of Corning Reactor Technologies: One decade of expertise

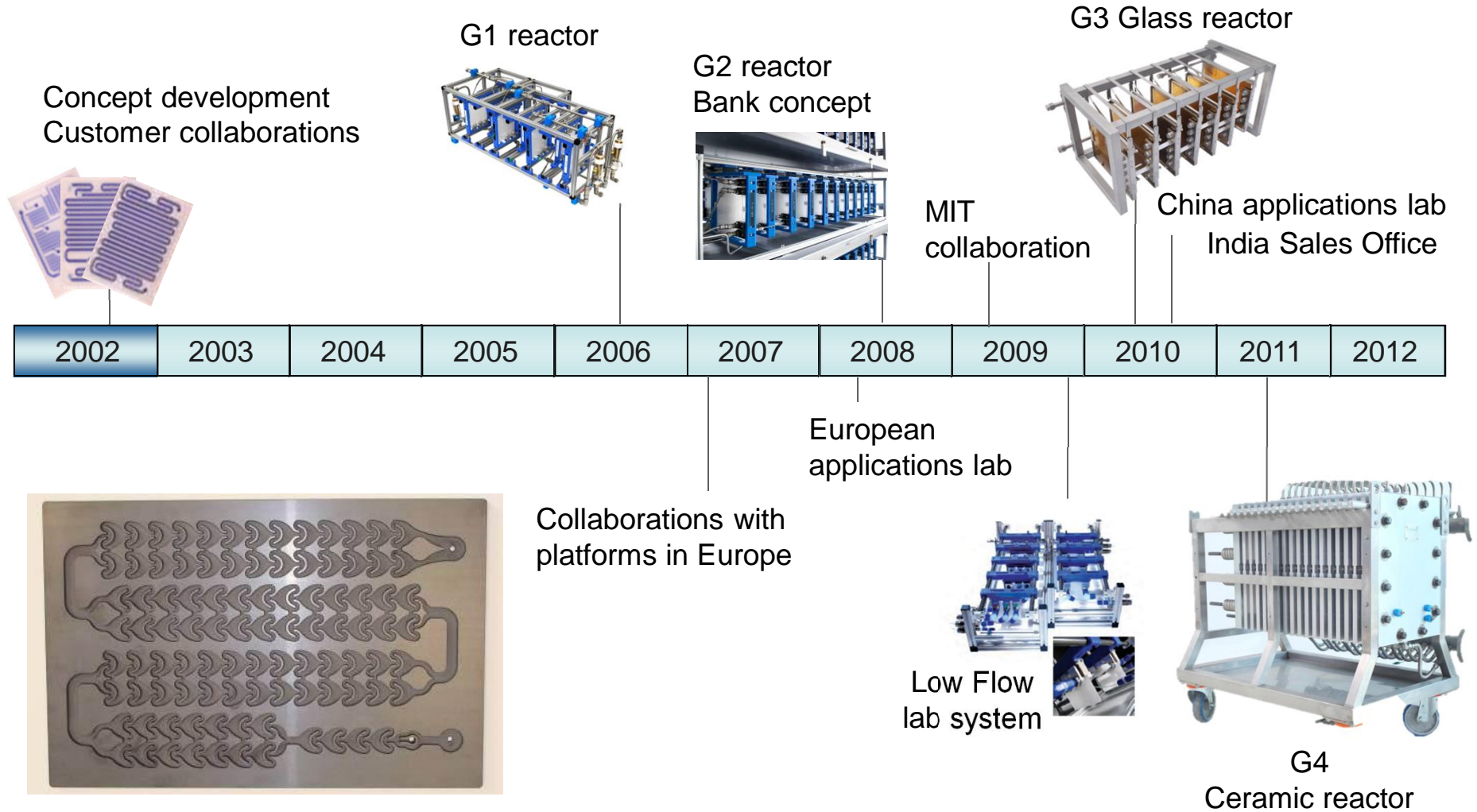

# Continuous flow reactors production range

Low Flow	G1	G2	G3	G4
0.45 ml	8 – 11 ml	21 – 25 ml	55 – 65 ml	200 – 260 ml
T° -60 to 200°C, P° up to 18 bar, metal-free reaction path				
				

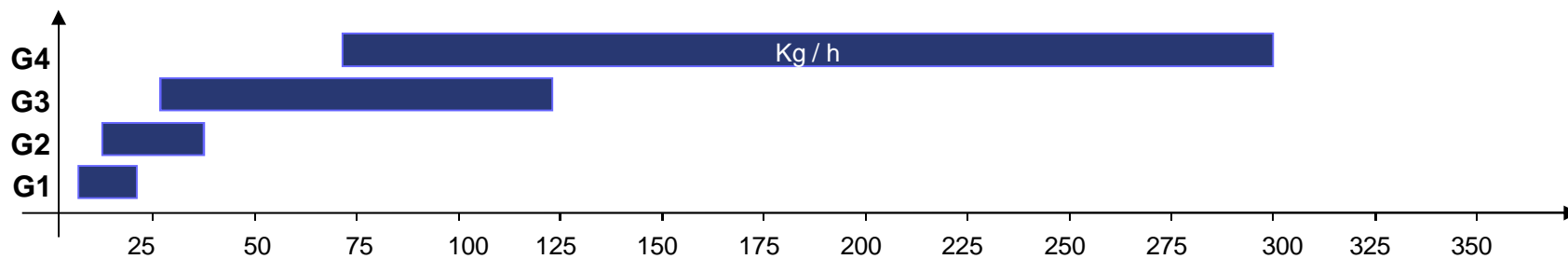

***Seamless Scale-up***

# Quality By Design and Continuous Flow Reactor

ICH Q8 (R2) emphasizes “ Product and **Process understanding and process Control**”

Was the wording “know –How” invented for the chemist?

We will focus particularly on API manufacturing and control

*What makes a chemical process easier to understand and to monitor in continuous flow reactor rather than in a batch reactor?*



# Process understanding

What are the requirements of the chemistry?

chemical reaction needs  $\longleftrightarrow$  chemical engineering capabilities of the equipment

Which parameters in the Chemical Process will influence the quality of the product, and to which extend (PAR, DS...)

How to predict in advance the influence of the size of the production equipment?

# Chemical reaction's need

## Chemist need

Contact between the molecules of the reactants

Keep the molecules in contact during a sufficient time to allow the completion of the reaction

Does not keep the molecules too long in contact to avoid side reactions

Isothermal condition / reaction enthalpy release

## Chemical engineering requirement

**MIXING / MASS TRANSFER**

**RT**

**RTD**

**HEAT TRANSFER**

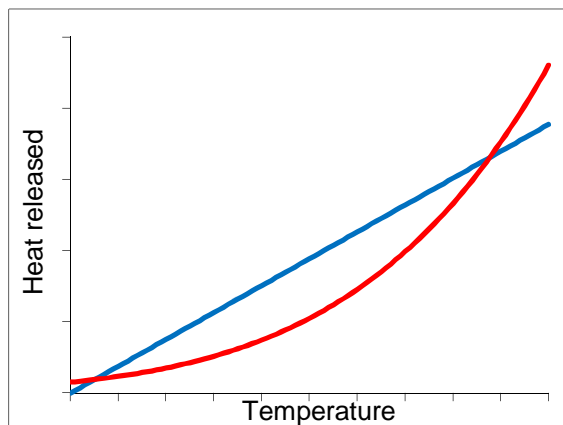

**What is the limiting factor:  
mass transfer or the  
kinetic of the reaction?**

# A nice tool for limiting factor assessment

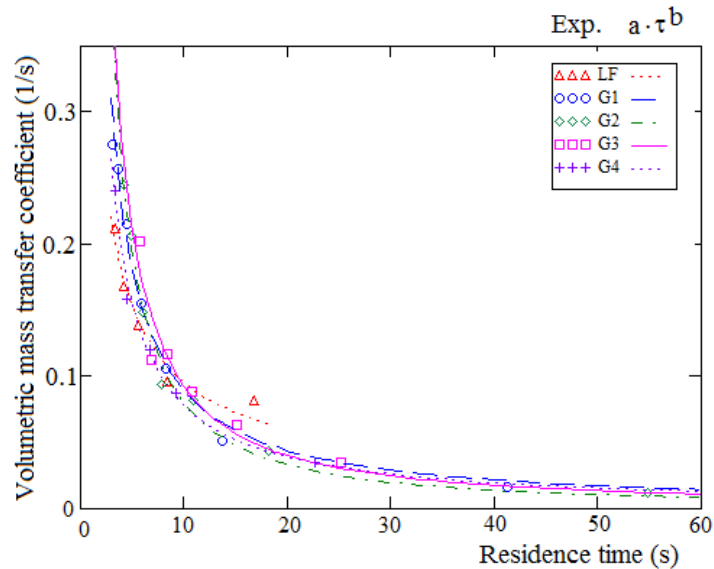

In Continuous flow reactor, most generally Mass transfer efficiency is directly linked to flow rate, and therefore easy to monitor

Organic phase	water phase	gas phase	temperature	inlet pressure	reactor volume	Apparent RT
ml/mn	ml/mn	sl/mn	°C	bar	ml	s

Run187	18	15,5	0,700	100,00	14,00	48,00	86,0
Run53	36	29	1,400	100,00	14,00	96,00	88,6

Product	Impurity 1	Impurity 2	Impurity 3
% area	% area	% area	% area

81,9	8,6	0,5	1,2
91,2	5,5	0,7	0,5

# Better knowledge of the process at lab scale with continuous flow

Dynamic and quick response

Plug flow behavior

Impressive number of steady state conditions in 8 hours.

The limitation is the analytical capability, not the continuous flow reactor delivery

# That can be directly extrapolated to production

Corning AFR reactors keep the chemical engineering reactor properties at the same value over all range, allowing a “seamless” scale-up from lab to production.

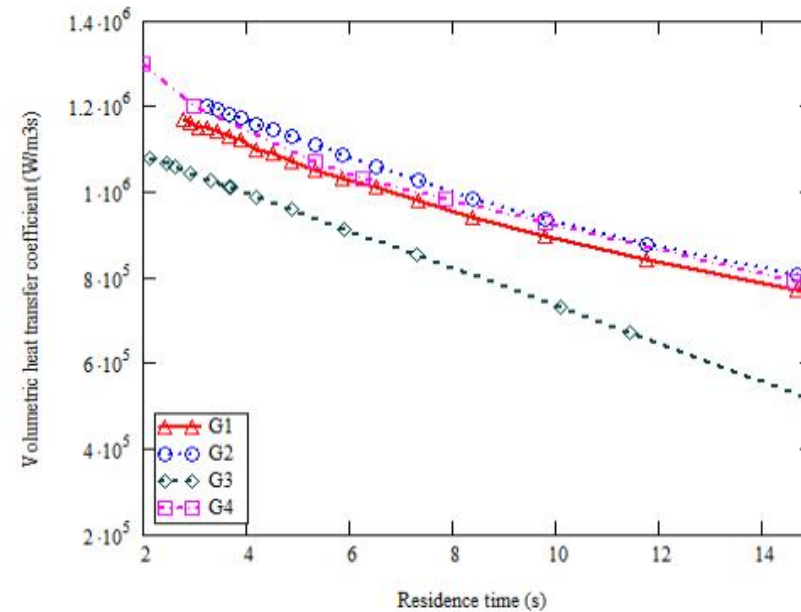
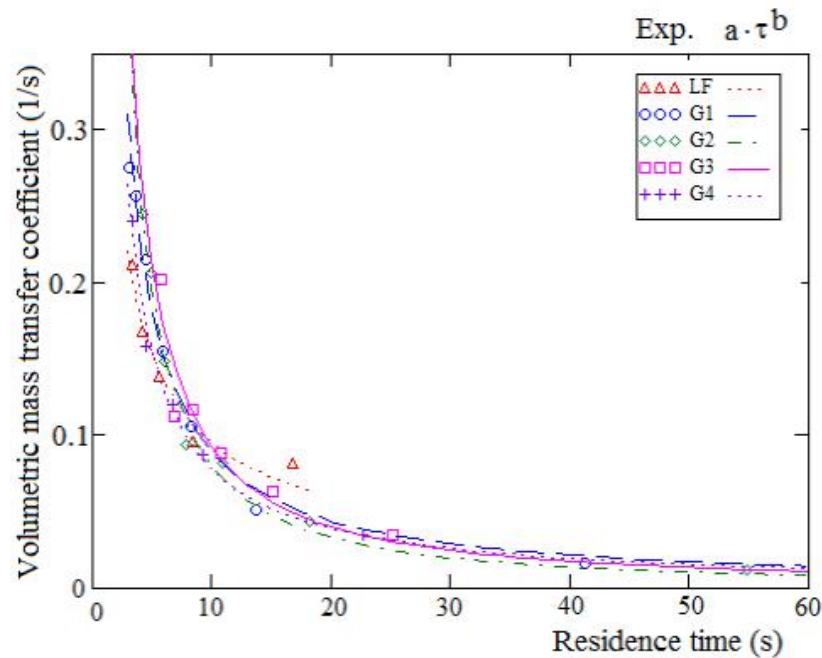

# Reactor capabilities versus reaction's need

If the reactor capabilities will be kept at the same level for all sizes, then the chemical needs will be satisfied at the same level, the output will then remain constant.

## Reactor capabilities

## Reaction's need

**MIXING / MASS TRANSFER**

✓ Contact between the molecules of the reactants

**RT**

✓ Keep the molecules in contact during a sufficient time to allow the completion of the reaction

**RTD**

✓ Does not keep the molecules too long in contact to avoid side reactions

**HEAT TRANSFER**

✓ Isothermal condition / reaction enthalpy release

# Actual scale-up from Lab to Pilot

Multiphase application: L/L/G

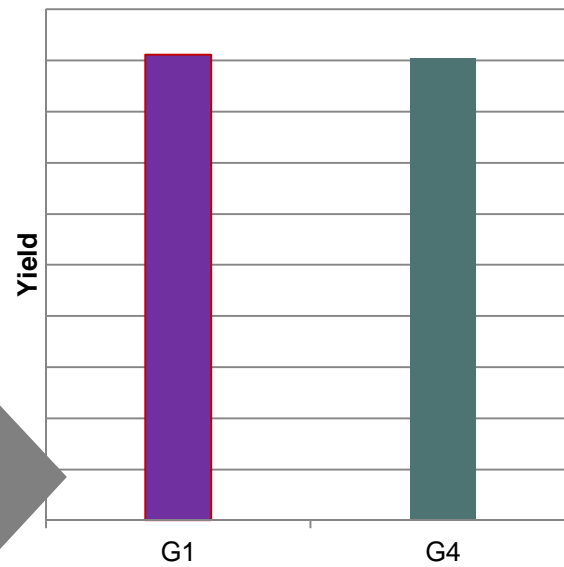

Production, G4  
2000 t/y

# Which positive effect for an API development?

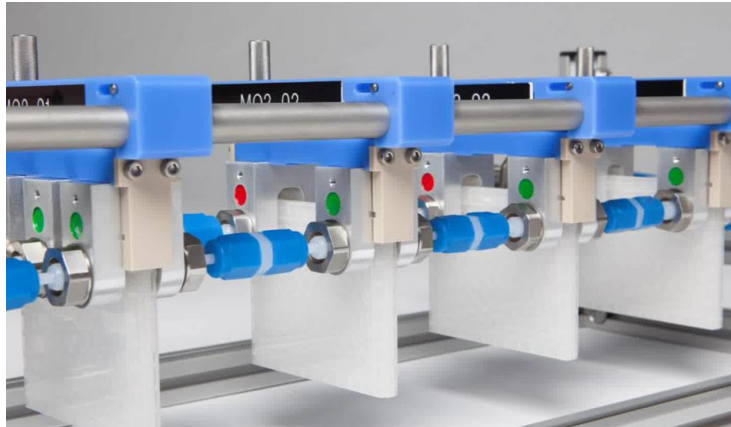

The process optimization made in lab at small scale, with few product, can be used directly in the production reactor

The PAR study can therefore be made at small scale and directly used for production as well, leading to time and material saving.



A prerequisite to control the process is to understand it (or at least to have a reliable and representative model –"black box")

Are on line measurement easier in continuous flow than in batch?

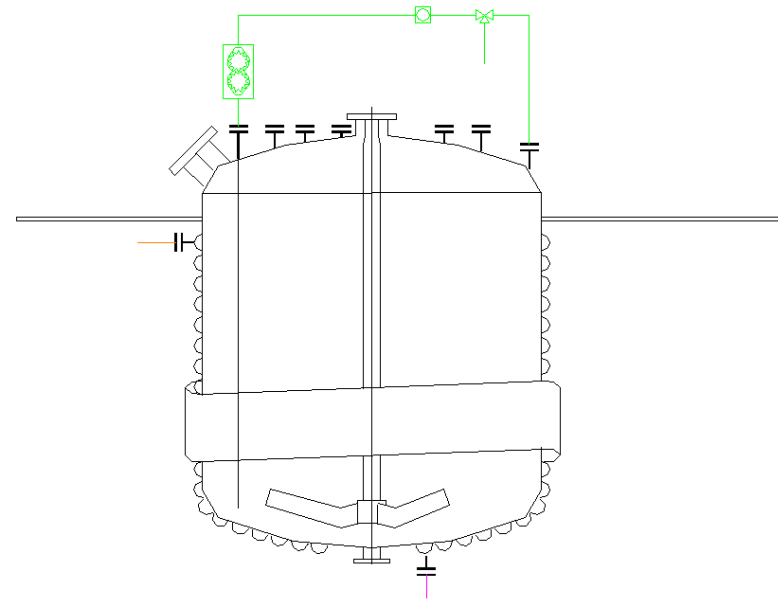

# Steady state and low inertia make the difference!

In steady state in a continuous flow reactor, time is no more a dimension

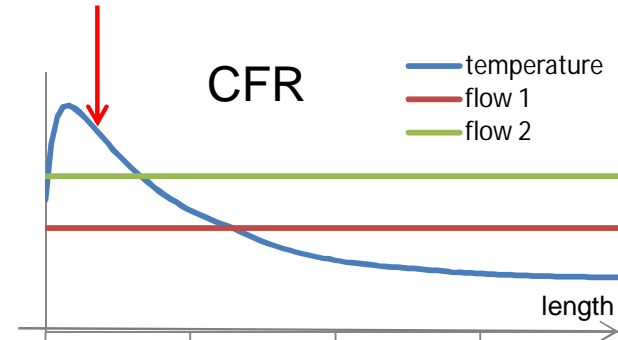
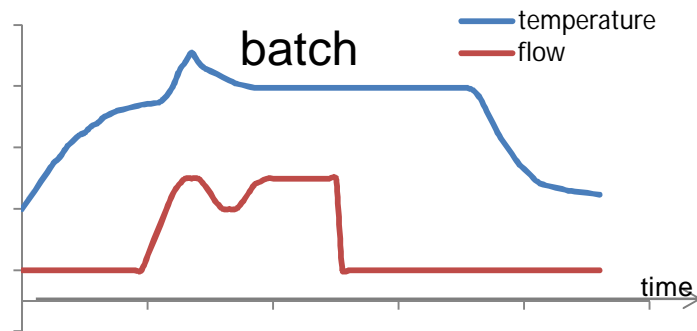

Any change in a parameter will be directly linked to a change in the process, not to the time anymore.

Therefore, the information has much more value.

Low thermal inertia, and plug flow behavior give a quicker response to any change, and make corrective action quicker and more efficient



	weight (kg)	volume (l)
batch	8000	5000
continuous flow	500	5
ratio	26	1000

# Which parameters to measure?

Process Temperature?

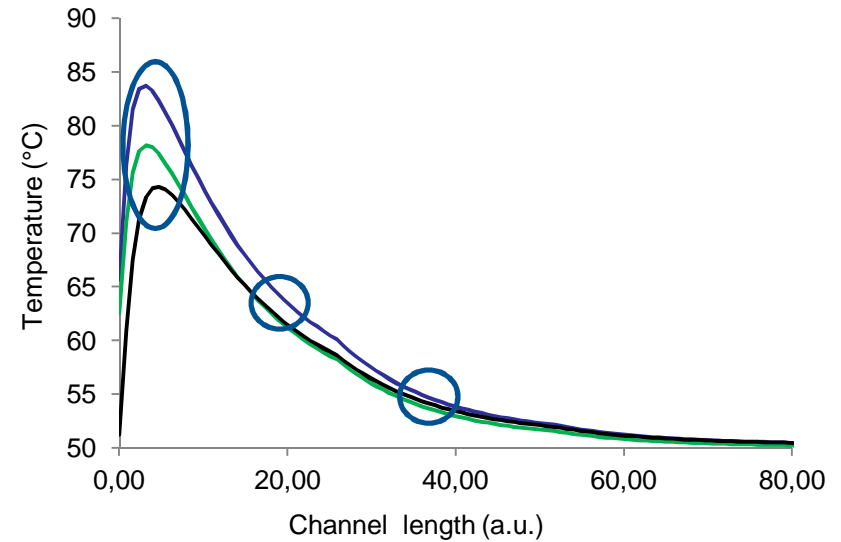
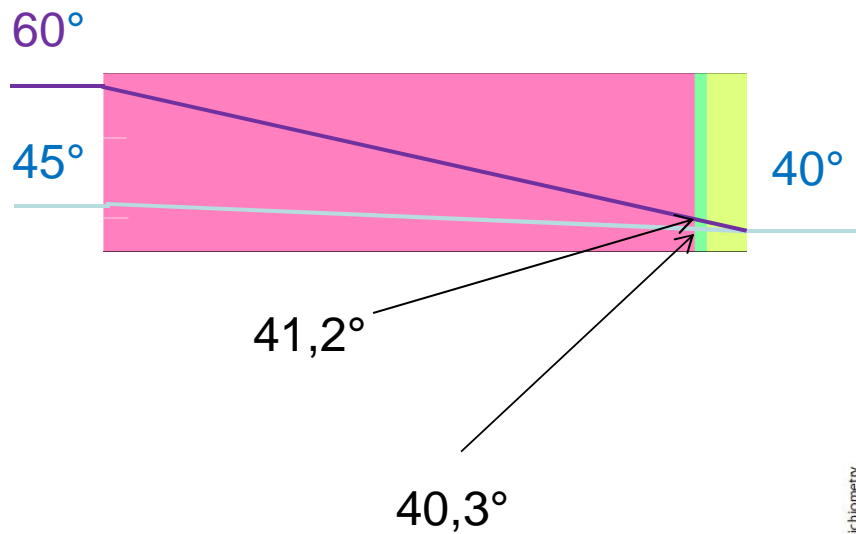

Flow

Pressure

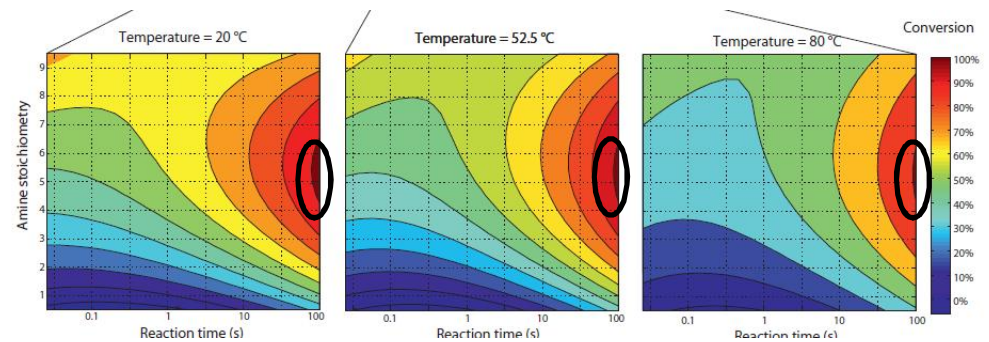

Access Flow. Application note N°1

# On line product analysis: An example of industrial case study

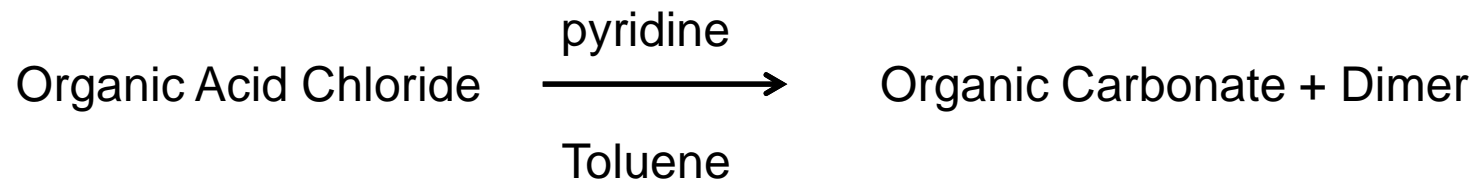

Partners: FDA:



CORNING:

CORNING

Kaiser Optical System  
(Raman RXN2™ Analyser)



Parker (NeSSi sampling system):



# Reactor lay out

## Advanced Flow Reactor Images

Raman Probes

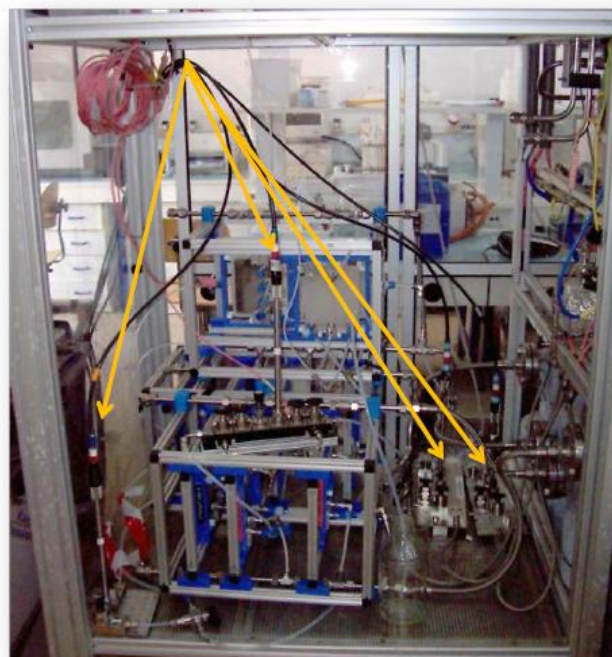
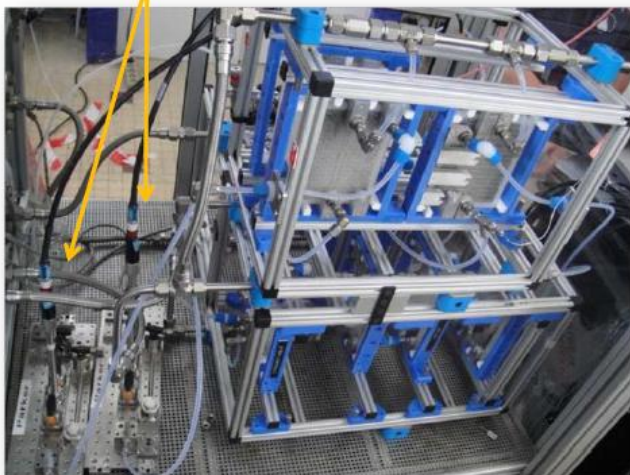

IMTeC 2010  
Brian Marquardt  
CPAC

# Raman shift spectrum

## 3D Plot of Raman Reaction Data

GC Results (%)					
Test	R-OH	2EHCF	R-Cl	Carbonate	Dimer
1	1.17	0.00	0.26	96.17	2.40
2	2.16	45.84	0.32	51.42	0.59

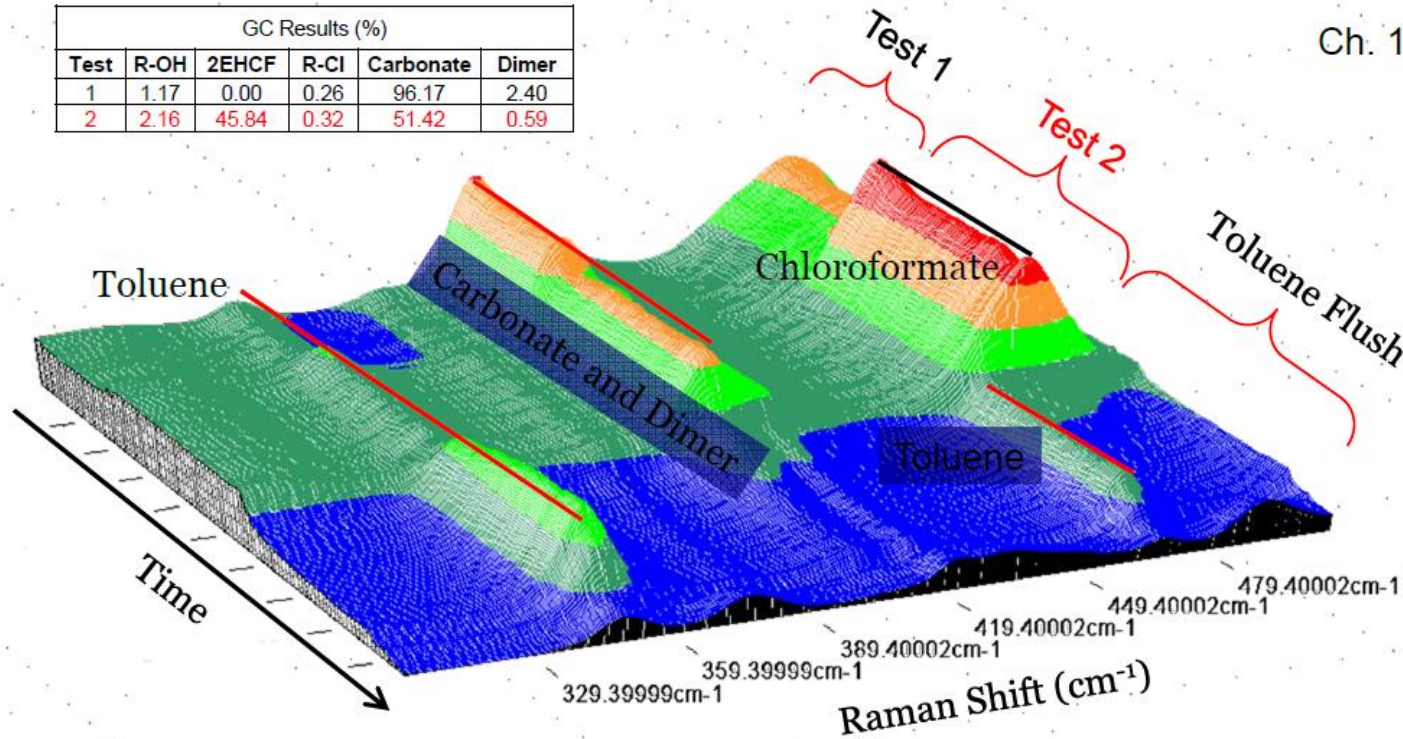

Ch. 1

IMTeC 2010  
Brian Marquardt  
CPAC

# Method calibration

## Reaction Profiles for 2 DoE Steps

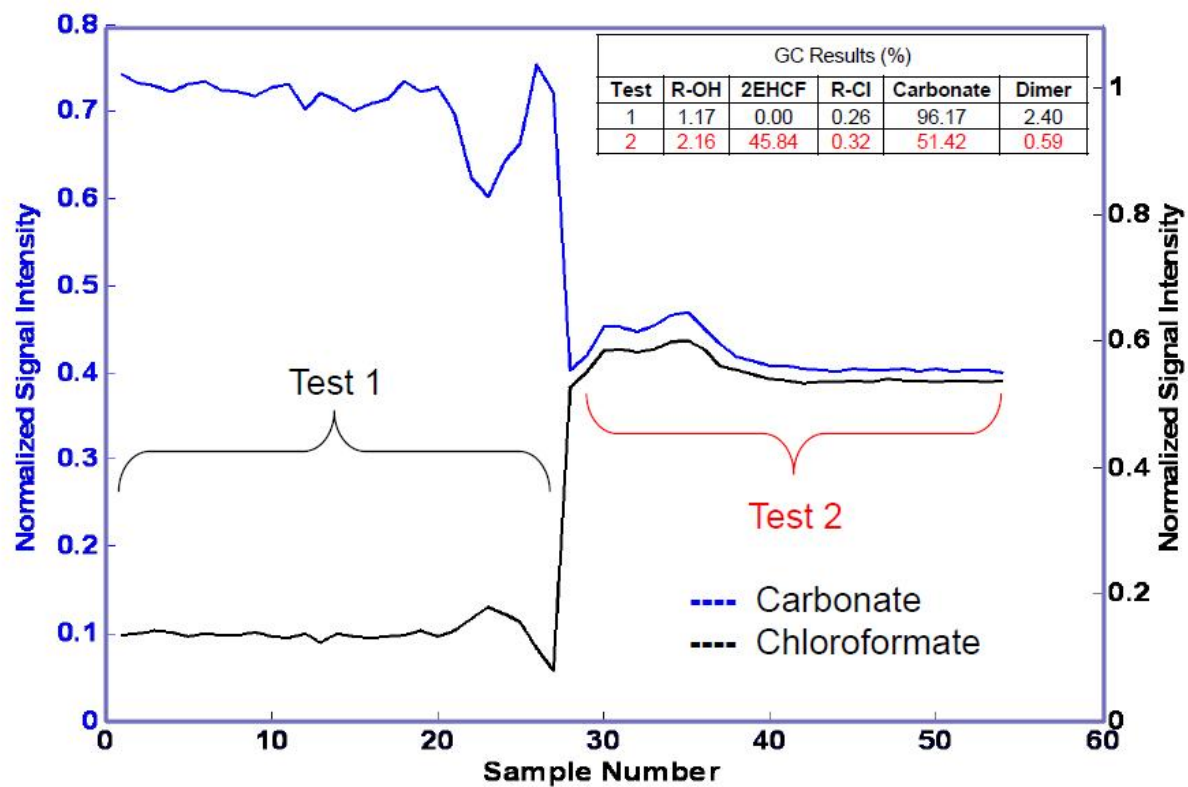

IMTeC 2010  
 Brian Marquardt  
 CPAC

# On line product Analysis in day to day work: photochemistry coupled with IR on line.

## ■ Corning PhotoReactor

- Intramolecular 2+2 photocycloaddition\*
- Corning AFR combined with light source
- Dominant emission line at 360 nm
- On-line Infrared Spectroscopy

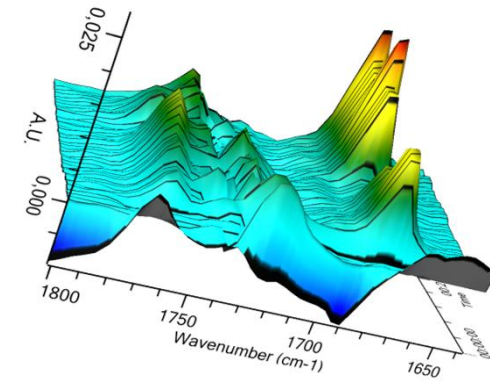
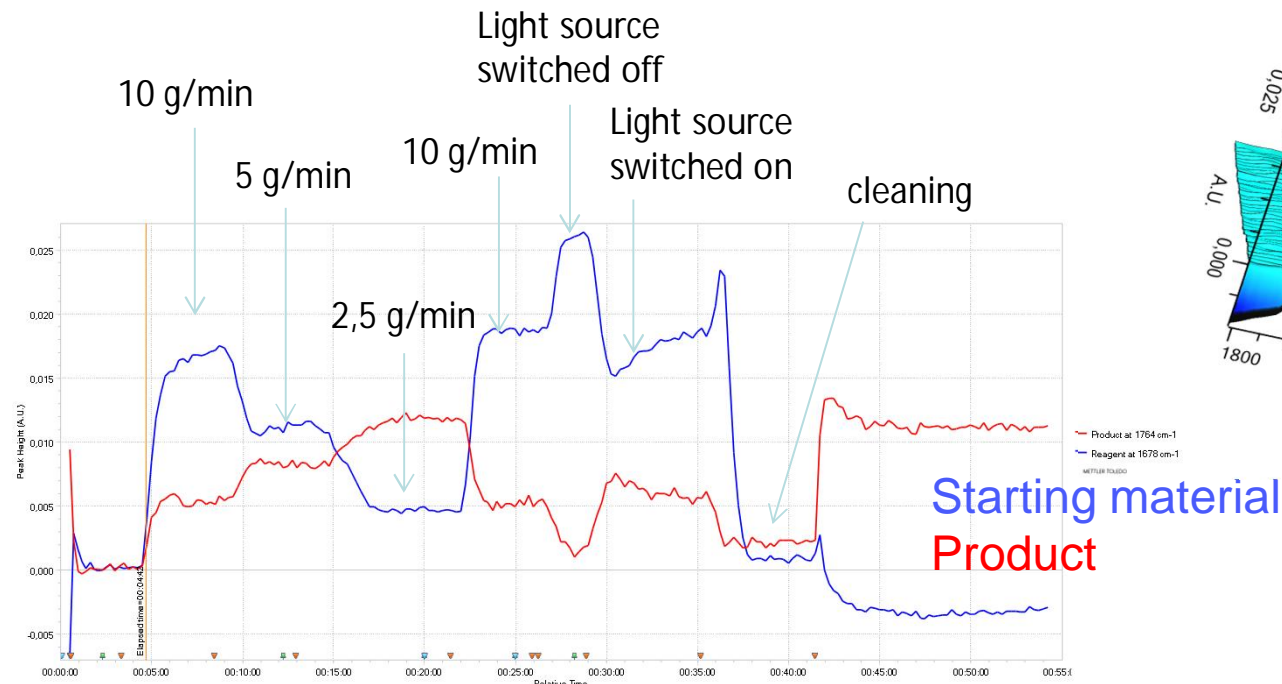
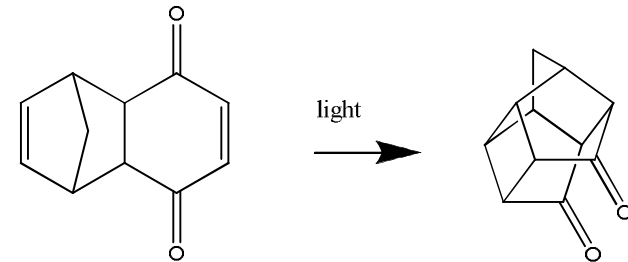

Mettler Toledo  
Read IR™ 15

Chemical Engineering and Processing 64 (2013) 38–47



# On line analysis: current limitation

On line analysis is not an universal tool.

Several technology are available in the market (IR, Raman, mass spectrometry...)

In any case, the utilization is not straightforward, a method has to be developed and validated.

The material of construction may be an issue for some cases (if metal free is required for corrosion issue...).

Response time?

# Material certification

Industrial continuous flow reactors are industrial equipment, manufactured according to codes and standard of quality and traceability.

All metal parts used are delivered with 3.1 certificate

SiC has been validated according FDA compliance policy guides 7171.06 (2005) and 7171.07 (2005)

Perfluoro elastomer gaskets are purchased with certificate of compliance with 21, CFR, part 177.1550

The choice of auxiliaries (pumps...) has been made with the support of Corning experience in pumps selection

## How to clean a continuous flow reactor?

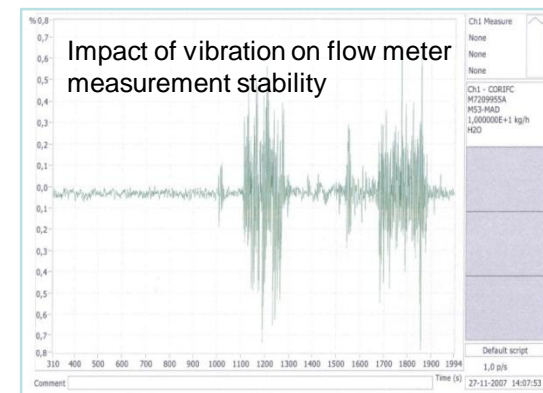

# Cleaning of Continuous Flow reactor: poor answers

How to clean a batch reactor?

A 6 000 l glass lined reactor has an internal surface of 23 m<sup>2</sup>.

Most generally, the reactor is fitted with a 24 m<sup>2</sup> exchanger (plus a 12 m<sup>2</sup> post condenser...)

Are the exchangers always open to check that they are clean?

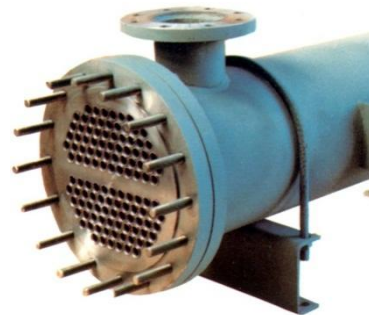

What about singularities  
(gaskets, pump...)

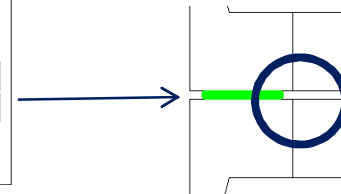
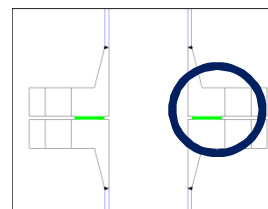

Dead volume 1200  
mm<sup>3</sup> for DN 50

If you can clean a batch reactor, you will clean a continuous flow reactor as well

# Cleaning of Continuous Flow reactor: better answers

The surface of glass or SiC reactor is very smooth ( $R_a < 1 \text{ nm}$ )

An AFR “equivalent” to a 6 m<sup>3</sup> GL reactor has a volume of 5 liter and a wetted surface of 3,5 m<sup>2</sup>

The flow can easily be turbulent with high mixing/ cleaning efficiency

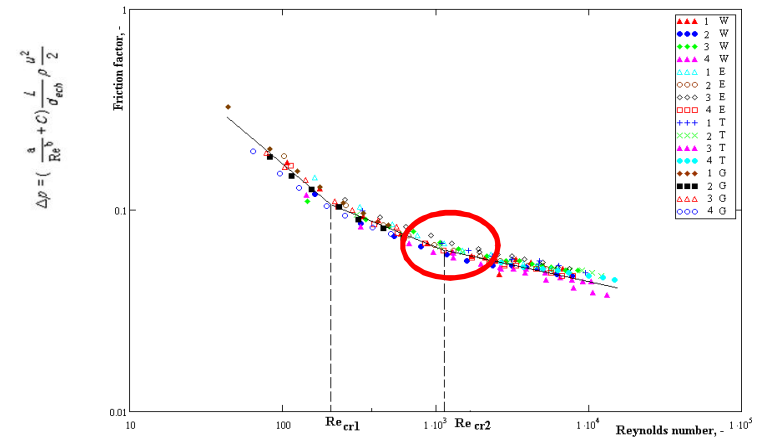
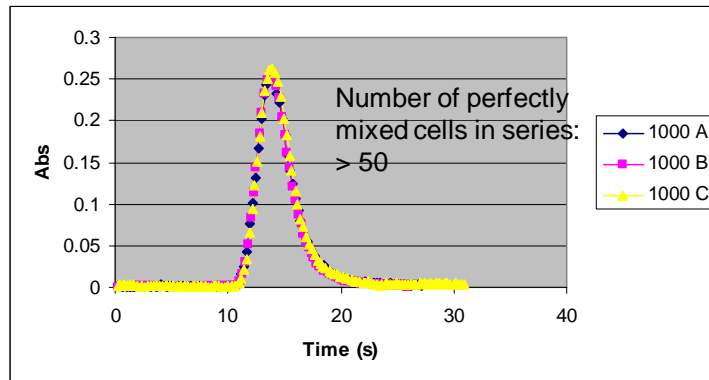

The flow is really a plug flow, which means virtually no dead zone.

Ultimately, drastic condition (dismounting and pyrolysis at high temperature) could be applied

The cleaning procedure and the demonstration of its efficiency is fully **part of the process** and has to be made at preliminary step



EUROPEAN COMPLIANCE  
ACADEMY

# A case of industrial production of an API with AFR

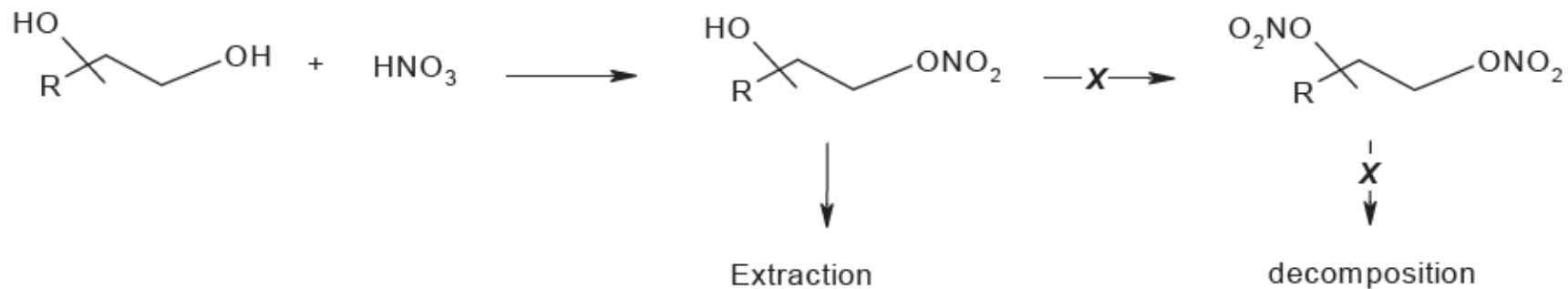

*Process Intensification:  
The Use of Microreactors and  
Centrifugal Contact Separators  
for Continuous Catalytic  
Processes*

David Ager  
DSM Pharma Chemicals  
PMB 150  
9650 Strickland Road Suite 103  
Raleigh NC 27615  
David.Ager@dsm.com

Unlimited. **DSM**

Scale-up Conference, 2010



2<sup>nd</sup> symposium on Continuous Flow reactor  
Technology for Industrial Applications, Paris,  
sept 2010)

# Moving forward step by step

- Process definition, robustness and optimisation (G1)
- Production of several hundred kg for stage II by numbering-up (8 G1)
- PAR for production (G2 size)
- Production of several tons for stage III by numbering-up and scale-up (12 G2)

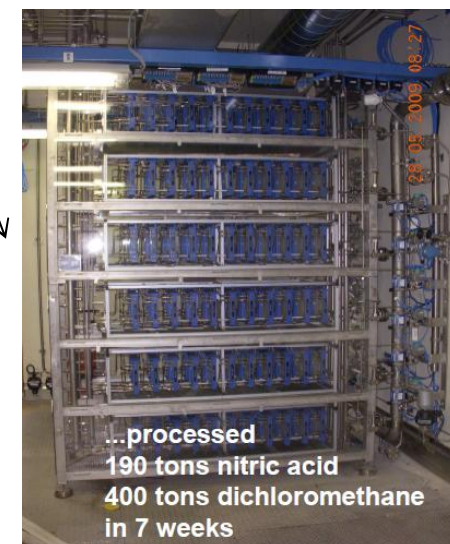

*All pictures courtesy of DSM*



EUROPEAN COMPLIANCE  
ACADEMY

# In a very short timeframe

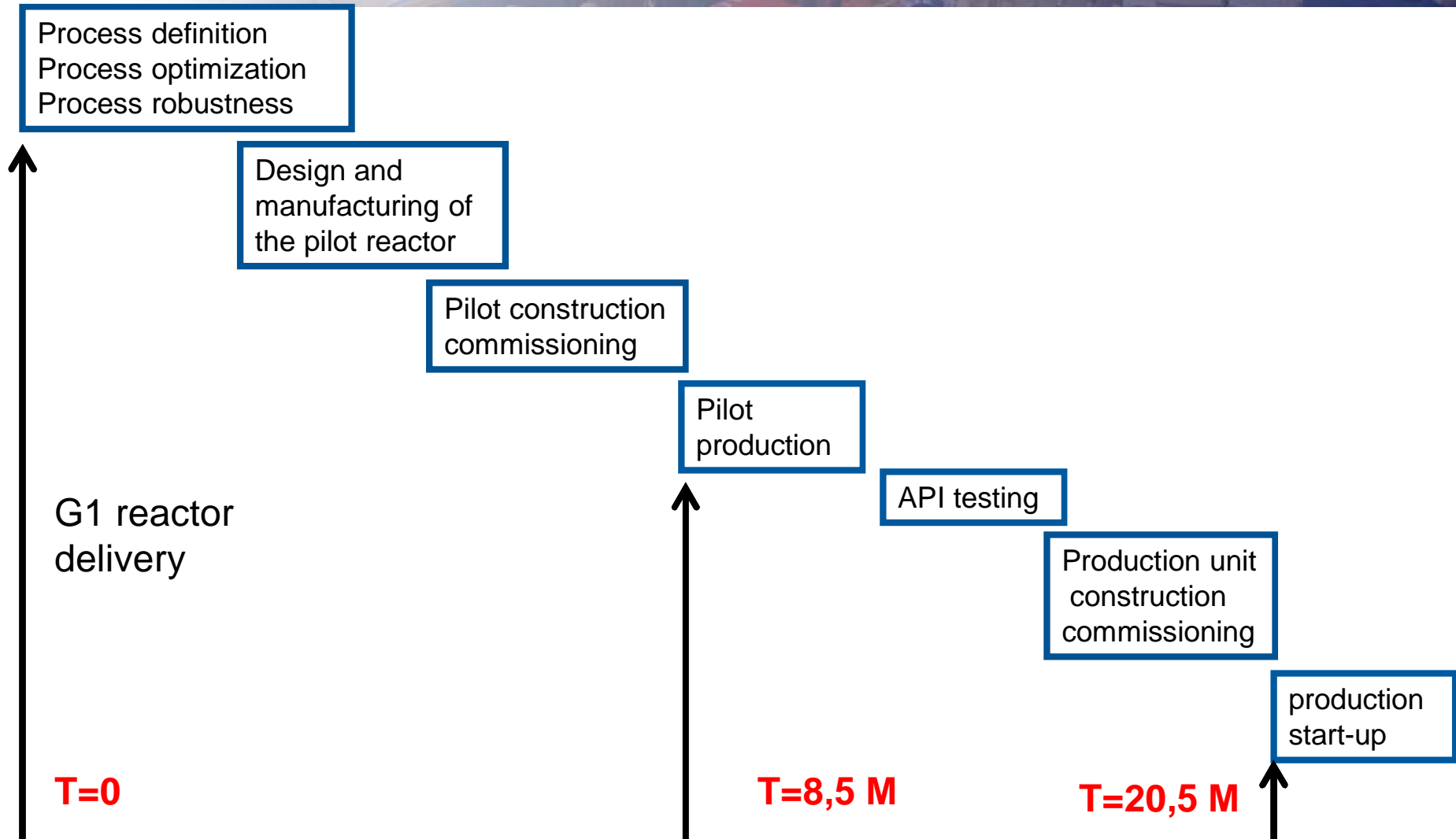

# From lab to pilot: fluid distribution

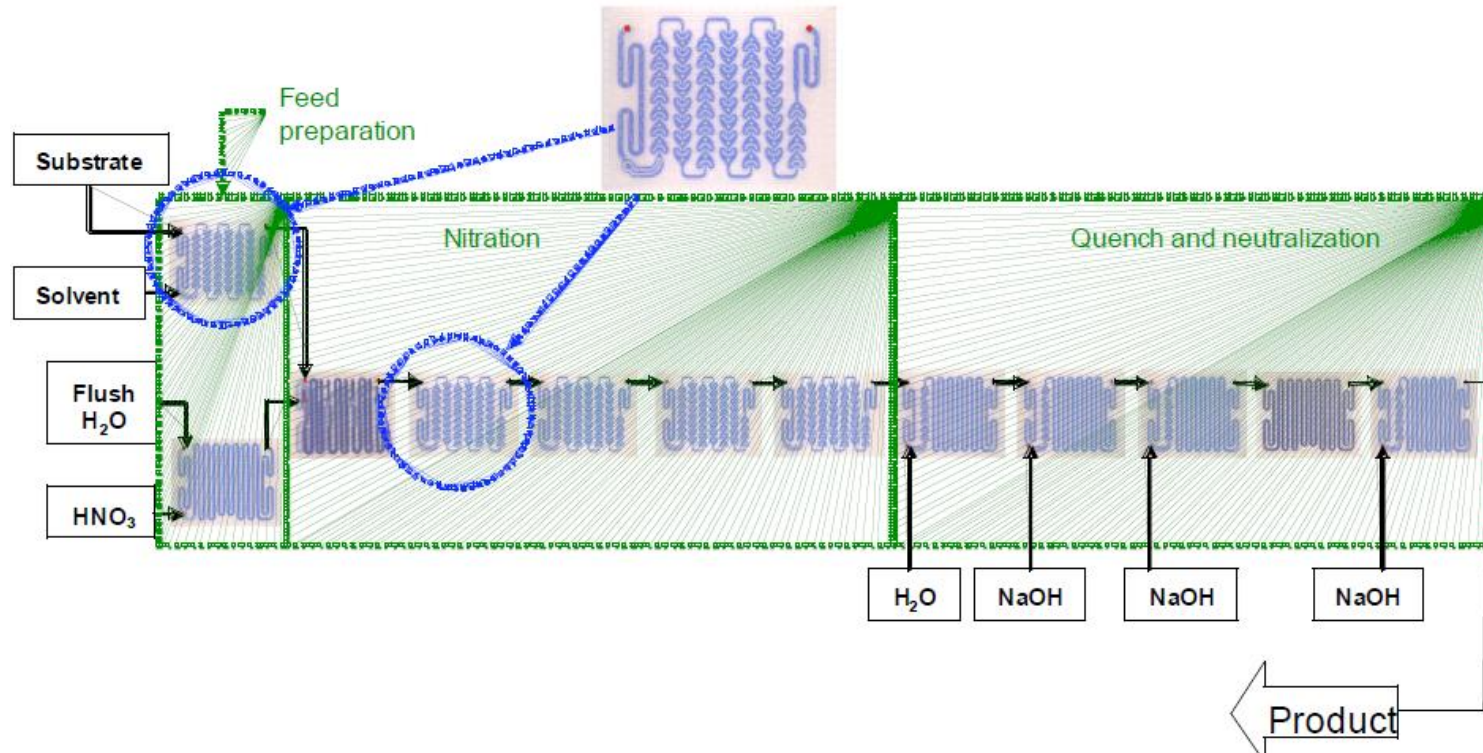

7 feeds time 8 reactors = 56 feed inlet

56 single pumps or control loop is not realistic!



# A flow control philosophy based on lab test and process robustness

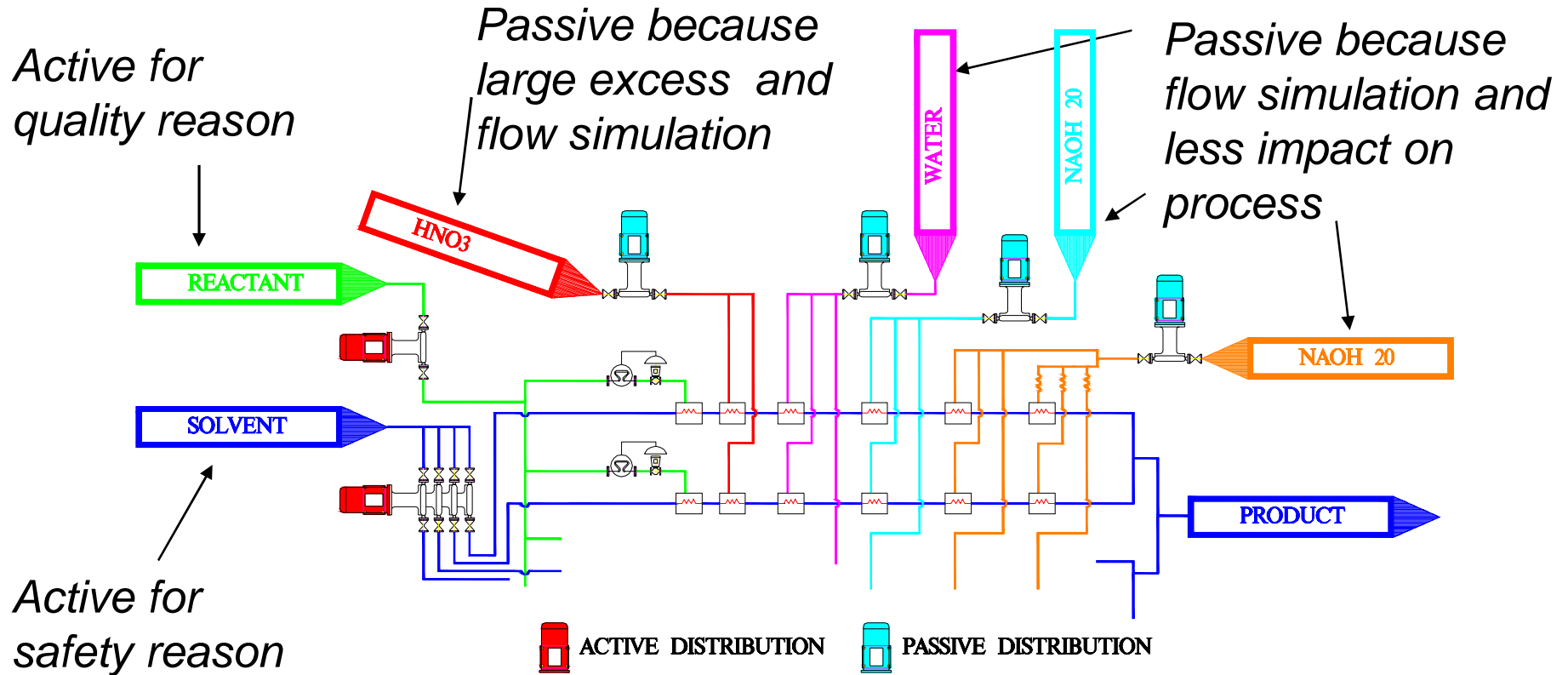

*All flows are monitored (mass flow meter or ball flow meter)*

*The only temperature measurement were on utility side and at the reactor outlet*

# Validation of process control system

## ➤ Flow modeling

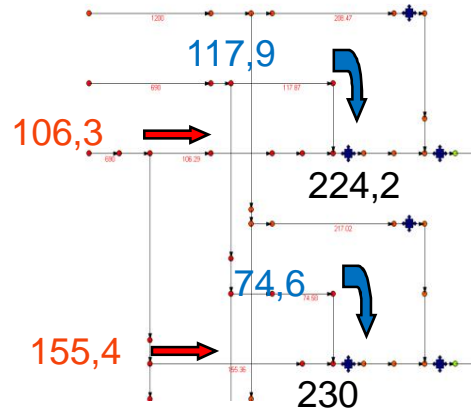

## ➤ Lab test and pilot water test

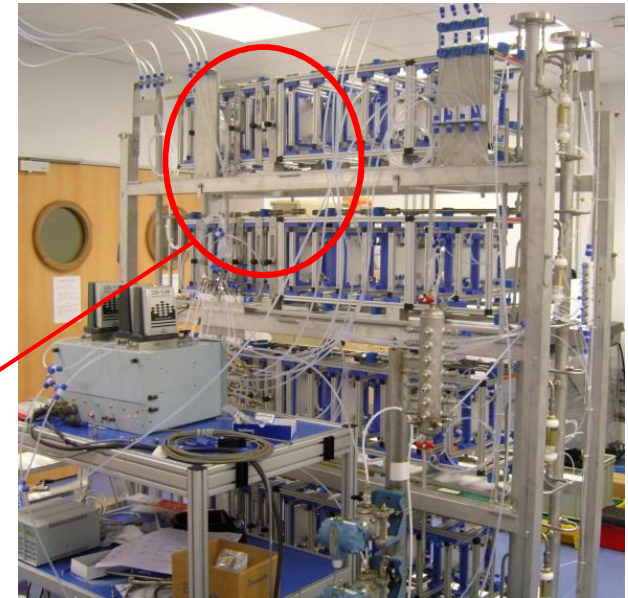
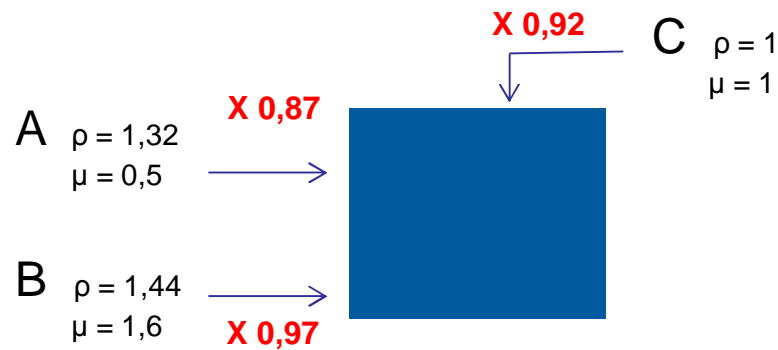

## ➤ Flow and quality monitoring during run of qualification

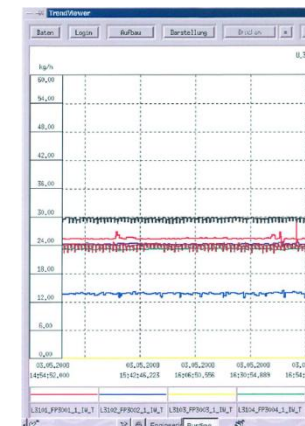
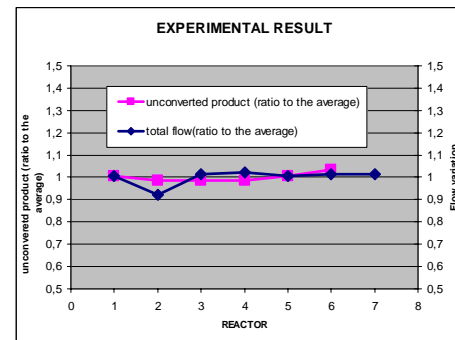

# What would be the picture today?

Lab test in G1

Pilot in 8 x G1

PAR in G2

Production in 12 x G2



Lab test in G1

Pilot in G4

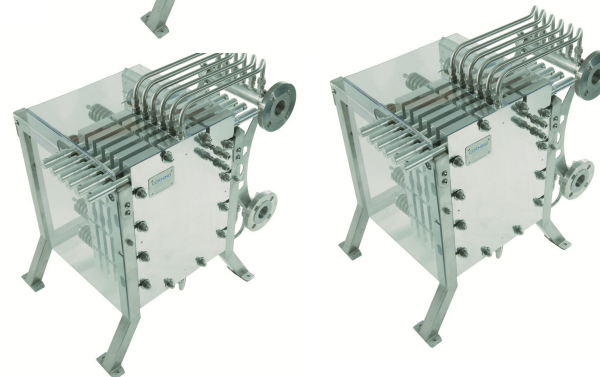
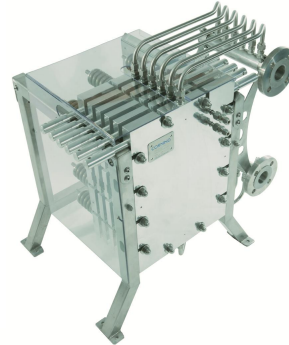

Production in 2 x G4

## Conclusion

Continuous flow bring significant advantages for the development and the production of API under c-GMP requirement.

The seamless scale-up of Corning® Advanced-Flow™ reactor allows to predict the behavior of the production reactor in the lab and the results of PAR study made in short scale can apply directly for production.

A good knowledge of the reaction mechanism is require to take full advantage of continuous flow, and to monitor closely the process.

Corning® Advanced-Flow™ reactor is an impressive tool for a better understanding of the chemical process.

# Conclusion

The more you know about your chemical reaction, the better you can control it.

On line analysis is not directly linked with continuous flow, even it may be useful for a better control of the reaction

The good parameters to check in continuous flow are not necessarily the same as you use to control in batch.

The cleaning of the reactor is not unpredictable, it has to be seen as a part of the process, and study and optimized accordingly.



***THANKS FOR  
YOUR ATTENTION***

***QUESTIONS?***

[guidatr@corning.com](mailto:guidatr@corning.com)

CORNING